

Article number: 439700220

Description: Rota-fix shaft-hub connection FL220x325

Note: Self centering - very high torque

## Measures

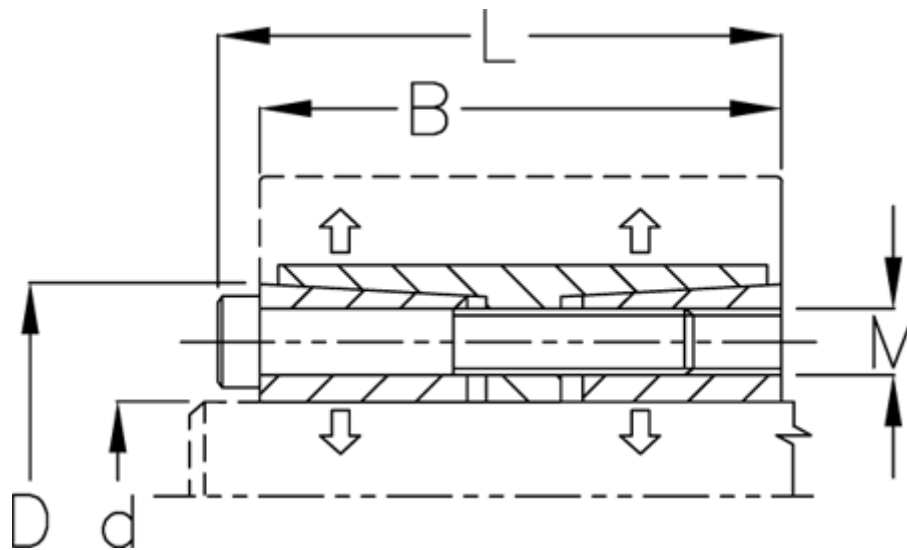

B mm	= 229
d H8 mm	= 220
D mm	= 325
Fit tolerance	= Aksel h8, Nav H8
F kN torque	= 2845.0
L mm	= 251
M mm	= M22
P N/mm <sup>2</sup> surface pressure on shaft/hub	= 129

Surface roughness	= R? ? 3.2 μm
T N m torque	= 313000
Ts N m bolt tightening torque	= 930.0